

Article number: 0101113
 Description: Retaining ring A 130 DIN 471
 Spring steel
 Note: Fitted with ZGA pilers

Measures

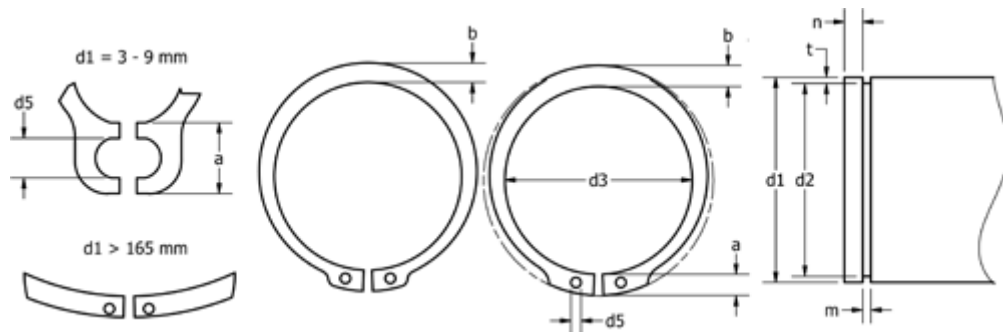

a max	= 11.6	FN kN	= 134.0	s	= 4.00
AN mm ²	= 804.0	FRg kN	= 55.20	t	= 2.00
b	= 10.7	FR kN	= 395.00	tol	= -0.63
d1	= 130	g	= 4.0	tol	= -0.10
d2	= 126.0	K kN-mm	= 852.00	tol	= +0,63-1,50
d3	= 123.0	m min	= 4.15	Tong	= ZGA-5
d5 min	= 4.0	n abl x 1000	= 3.0	Weight kg/1000	= 100.000
Description	= A130	Nominal drive	= 6.0		